

# SPECIFICATION

# CTEZED 25 HV

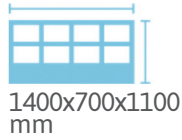

## WORKING ENVELOPE

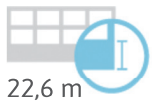
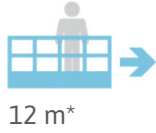
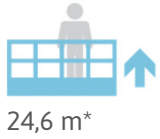
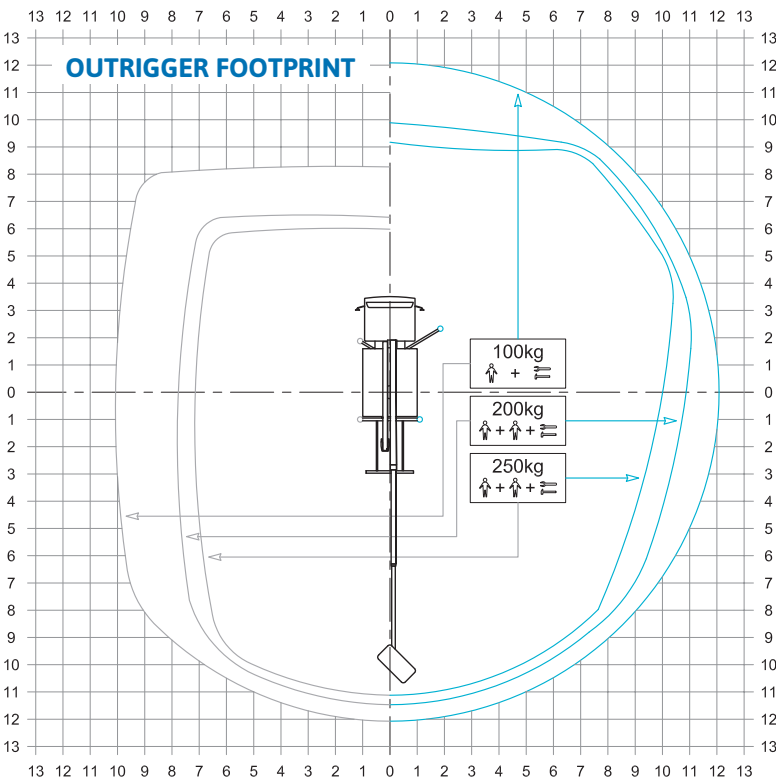
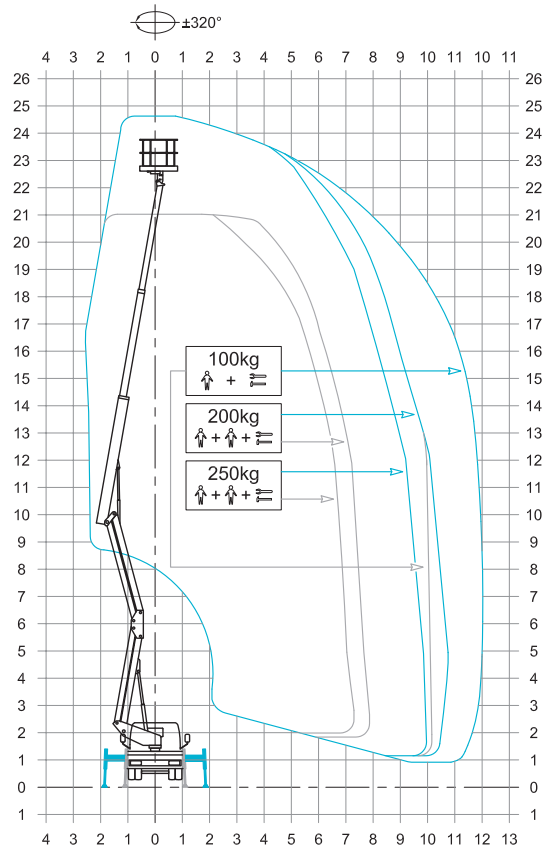

\* outreach and height max values and repeatability can change within ± 3% due to manufacturing variation and working condition.

## DIMENSIONS

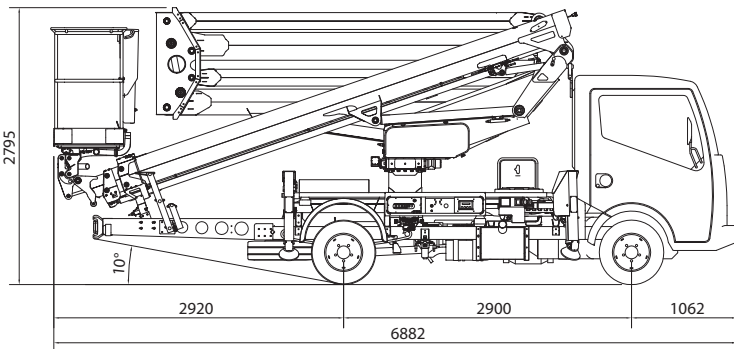
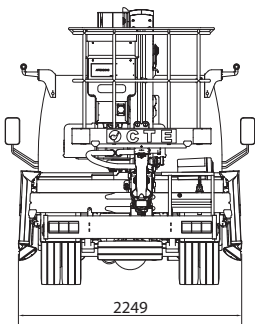

**CTE S.p.A.**

Headquarter 7 Via Caproni - Rovereto (TN) IT, 38068

Ph. +39 0464 48.50.50 - Fax +39 0464 48.50.99

info@ctelift.com - [www.ctelift.com](http://www.ctelift.com)

Factory 5 Loc. Terramatta - Rivoli Veronese (VR) IT, 37010

CTE UK Ltd Enderby Leicestershire - UK

Product specifications are subject to change without notice or obligation. Technical features and drawings in this brochure are for illustrative purposes only. \_ZED 25 HV - ed. 10/18

